

MANUAL

PROFIBUS POWER HUB COMPACT

KT-MB-GTB-2PS

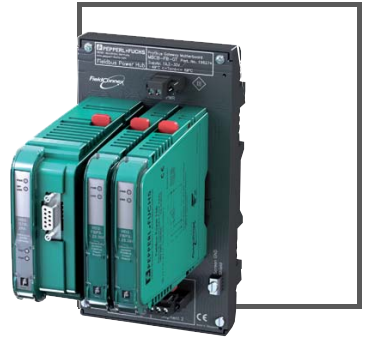



With regard to the supply of products, the current issue of the following document is applicable: The General Terms of Delivery for Products and Services of the Electrical Industry, published by the Central Association of the Electrical Industry (Zentralverband Elektrotechnik und Elektroindustrie (ZVEI) e.V.) in its most recent version as well as the supplementary clause: "Expanded reservation of proprietorship"

1	Safety	4
1.1	General	4
1.2	Used Symbols.....	4
1.3	Declaration of Conformity	5
1.4	Intended Use.....	5
1.4.1	Identification	5
1.5	Delivery, Transport and Storage.....	6
1.6	Installation and Commissioning	6
1.7	Repair	6
1.8	Disposal	6
2	Product Specifications	7
2.1	Function	7
2.2	Scope of Delivery	8
2.3	Component Overview and Dimensions.....	9
2.4	Technical Data	9
3	Installation	11
3.1	Mounting	11
3.2	Connection.....	14
3.3	Shielding / Grounding.....	15
4	Commissioning	16
4.1	Cyclic Data Exchange	16
4.1.1	Information on GSD conversion	16
4.1.2	Additional Information about Watchdog Time	18
5	Operation	20
5.1	LED Displays at the DP/PA Gateway	20
5.2	LED Displays on the Power Supply Module.....	21

1 Safety

1.1 General

The operator of the system is responsible in terms of planning, mounting, commissioning, operating and maintenance.

Installation and commissioning of all devices must be performed by a trained professional only.

Protection of operating personnel and the system is not ensured if the product is not used in accordance with its intended purpose.

Laws and regulations applicable to the usage or planned purpose of usage must be observed. Devices are only approved for proper usage in accordance with intended purpose. Improper handling will result in voiding of any warranty or manufacturer's responsibility.

The Declaration of Conformity, Certificate of Compliance, Statement of Conformity and data sheets are an integral part of this document. The data sheet contains the electrical data of the Declaration of Conformity and the Certificate of Compliance.

The documents mentioned are available from <http://www.pepperl-fuchs.com> or contact your local Pepperl+Fuchs representative.

1.2 Used Symbols

Safety-relevant Symbols



Danger!

This symbol indicates a warning about a possible danger.

In the event the warning is ignored, the consequences may range from personal injury to death.



Warning!

This symbol indicates a warning about a possible fault or danger.

In the event the warning is ignored, the consequences may course personal injury or heaviest property damage.



Caution!

This symbol warns of a possible fault.

Failure to observe the instructions given in this warning may result in the devices and any connected facilities or systems develop a fault or fail completely.

Informative Symbols



Note!

This symbol brings important information to your attention.



Action

This symbol marks an acting paragraph.

1.3

Declaration of Conformity

All products have been developed and manufactured taking into consideration applicable European standards and regulations.



Note!

A Declaration of Conformity can be requested from the manufacturer.

The manufacturer of this product, Pepperl+Fuchs GmbH in D-68301 Mannheim, Germany, has a certified quality assurance system in conformity with ISO 9001.



ISO9001

1.4

Intended Use

Pepperl+Fuchs PROFIBUS Power Hub serves as a Segment Coupler for connecting PROFIBUS PA segments to a PROFIBUS DP. The PROFIBUS Power Hub can be used in all system environments in compliance with industry standard PROFIBUS DP Masters.

Segment Couplers are the interface between the PROFIBUS DP and PROFIBUS PA. They ensure communication and galvanic isolation between PROFIBUS DP and PROFIBUS PA. PROFIBUS PA is an extended version of the PROFIBUS DP that allows for the physical transmission specifications of IEC 61158-2. Fieldbus devices receive their electrical supply through the transmission lines.



Note!

More recent documentation also uses the term PROFIBUS MBP in connection with PROFIBUS PA. MBP stands for Manchester Coded Bus Powered. PROFIBUS PA and PROFIBUS MBP are identical. The following section uses only the term PROFIBUS PA, which has been widely introduced and is current. PROFIBUS MBP-IS refers to the intrinsically safe version of the PROFIBUS MBP.

1.4.1 Identification

The individual components in the Compact PROFIBUS Power Hub Kit KT-MB-GTB-2PA are identified as follows:

DP/PA Gateway	Power Supply Module	Motherboard
Pepperl+Fuchs GmbH 68301 Mannheim/ Germany HD2-GTB-2PA	Pepperl+Fuchs GmbH 68301 Mannheim/ Germany HD2-FBPS-1.25.360 TÜV ATEX 2500 X	Pepperl+Fuchs GmbH 68301 Mannheim/ Germany MBCB-FB-GT



II 3 G Ex nA C IIC T4

1.5 Delivery, Transport and Storage

Check the packaging and contents for damage. In the event of damage, notify the postal service or express agent and inform the supplier.

Check the scope of supply for completeness and correctness using the order and delivery papers.

Keep the original packaging.

The device should always be stored or transported in the original packaging.

Always store the device in a dry and clean environment. Observe the permissible storage temperature (see data sheet).

1.6 Installation and Commissioning

The device should always be installed **outside of areas posing a danger of explosion**.

1.7 Repair

The devices may not be repaired, changed or manipulated. If there is a defect, the product must always be replaced with an original part.

1.8 Disposal

Disposal of devices and their packaging material must be performed in compliance with the applicable laws and guidelines of the corresponding country.

The devices do not contain batteries which need to be disposed of separately from the products.

2 Product Specifications

2.1 Function

The Compact PROFIBUS Power Hub is a segment coupler for single or twin-segment processing systems. Up to 31 PROFIBUS PA devices per segment can be connected to the control or process control system via PROFIBUS DP. One segment coupler performs two tasks simultaneously:

- transparent coupling of PROFIBUS PA segments to the PROFIBUS DP line.
- power supply to the PROFIBUS PA field devices.

The PROFIBUS Power Hub design is based on a motherboard with plug-in modules for each of the functions. The following table lists the type code for the kit and individual components.

The individual components in the kit are available as spare parts.

Type code	Component	Description
KT-MB-GTB-2PS	Kit	Complete package consisting of the components listed below (see chapter 2.2)
HD2-GTB-2PA	Gateway Module	Connects a maximum of two PA segments to the DP line
HD2-FBPS-1.25.360	Power Supply Module	Power Hub Power Supply Module. Output: 25 ... 28 V, 360 mA Two modules per Compact PROFIBUS Power Hub
MBCB-FB-GT	Motherboard	Motherboard for one gateway and two Power Supply Modules

The Compact PROFIBUS Power Hub was specially developed for small systems which only require one or two segments and have only a few PA field devices installed. The functions of the Hub are compatible with those of its predecessor, the Pepperl+Fuchs Segment Coupler SK 2.

Segment Coupling

PROFIBUS DP (DP) and PROFIBUS PA (PA) are very similar protocols. Data sent via DP or PA networks are essentially interpreted in the same way; however, the physical layer used to transfer the data is different. The most significant difference is that the PA supplies both power and data via the same cable; therefore it is suitable for harsher environments such as processing plants. The PA network is typically connected to a larger DP installation. The main differences are listed below.

Attribute	PROFIBUS PA	PROFIBUS DP
Physical layer	Manchester Bus Powered IEC 61158-2	RS 485
Communication speed	31.25 kbps fixed, synchronous	9.6 kbps ... 12 Mbps, asynchronous
Bits per byte	8	11

These similarities enable the use of Segment Coupler technology for the PROFIBUS Power Hub. The Hub establishes a transparent PA and DP connection. All PA field devices appear as if they were connected directly to the DP network. The PA devices are set up in the process control system or DP master in the same way as normal DP slaves. The Segment Coupler responds to requests from the DP master under the guise of the respective PA slave addressed by the DP master in the telegram.

The Compact PROFIBUS Power Hub requires no manual configuration. The device configures itself when the DP master initializes communication and becomes transparent for the control system and the field devices.

Each segment at the PA end has a fully functional PA master for fast, independent segment communication. The PA master imitates the DP master. The Segment Coupler offers the following functions:

- Conversion of the PROFIBUS DP to the physical layer on the PROFIBUS PA
- Adaptation of DP and PA transfer rates
- Electrical isolation between PROFIBUS DP and PA
- LEDs for basic function diagnostics

Power Supply

Power is supplied to the slaves via the power modules connected to the motherboard. The motherboard is capable of accommodating two Power Modules, one for each segment. There is always an electrical isolator between the segments on the Power Supply Modules and between the segments and the PROFIBUS DP. LEDs on the front panel indicate normal operation or error conditions.

The Compact PROFIBUS Power Hub has a long service life, ensures maximum packing density in the switch cabinet, has low power dissipation properties and decreases the need for cooling in the switch cabinet.

An impedance connected in series with the power supply is an integral component of the module. This impedance protects the communication signal, which is transmitted as a rectangular AC voltage, from short circuits due to the low internal resistance of the power supply. One key configuration characteristic is the exclusive use of passive components to generate this impedance, which increases the signal quality and extends the service life of the Power Supply Module.

2.2 Scope of Delivery

KT-MB-GTB-2PS Compact PROFIBUS Power Hub Kit

Quantity	Designation	Description
1	MBCB-FB-GT	Motherboard for mounting on a DIN rail. One slot for the DP/PA Gateway and two slots for two Power Supply Modules, one for each segment.
1	HD2-GTB-2PA	DP/PA Gateway, 2-channel.
2	HD2-FBPS-1.25.360	Isolated Fieldbus Power Supply Module with an output of 25 ... 27 V DC and 360 mA.

2.3 Component Overview and Dimensions

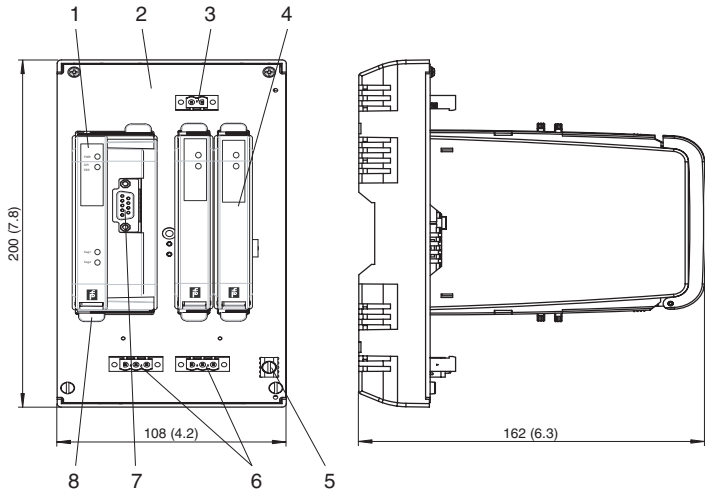

- 1 PROFIBUS DP/PA Gateway HD2-GTB-2PA
- 2 Motherboard MBCB-FB-GT
- 3 Power supply connection
- 4 Power Supply Module HD2-FBPS-1.25.360
- 5 Screen/ground connection clamp
- 6 PA trunk connections
- 7 PROFIBUS DP connection
- 8 Quick-Lok bar

2.4 Technical Data

KT-MB-GTB-2PS

Supply

Rated voltage	19.2 ...35 VDC
Rated current	1.46 ... 0.77 A
Power loss	typically 6.7W

Fieldbus Interface

Rated voltage	25...28 VDC
Rated current	360 ... 10 mA
Short-circuit current	typically 400 mA
PROFIBUS DP Connection Protocol	Sub D socket, 9-pin PROFIBUS DP/DP V1

Ambient conditions

Ambient temperature	-40...60 °C
Storage temperature	-40...85 °C

Mechanical specifications

Protection degree	IP 20
Mounting	DIN rail, system M36

3 Installation

3.1 Mounting

Read the chapter on Safety and, in particular, the section on Installation and Commissioning (see chapter 1.6) before installing the device.



Mounting of Fieldbus Motherboards on DIN mounting rail

To mount a motherboard on a DIN mounting rail, proceed as follows:

1. Place the motherboard on the mounting rail.
2. Tighten the fastening screw to attach the motherboard on the DIN rail.

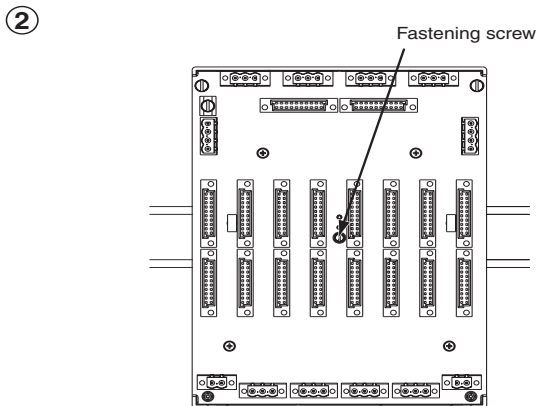
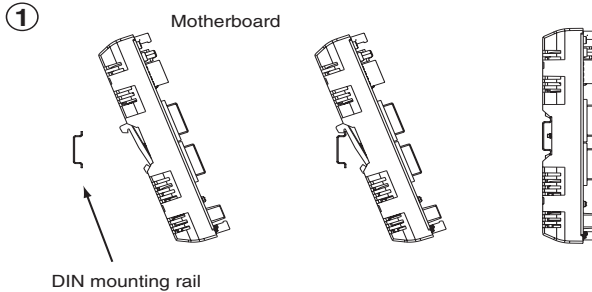

The motherboard has been mounted.



Mounting of HD2*-Modules on the motherboard

To install a new module on the motherboard, proceed as follows:

1. Carefully center the polarisation holes and mate the two connectors, then gently press down the module.
2. Push down the red Quick LOK bars on each side of the module to fix it to the panel (no tools required).

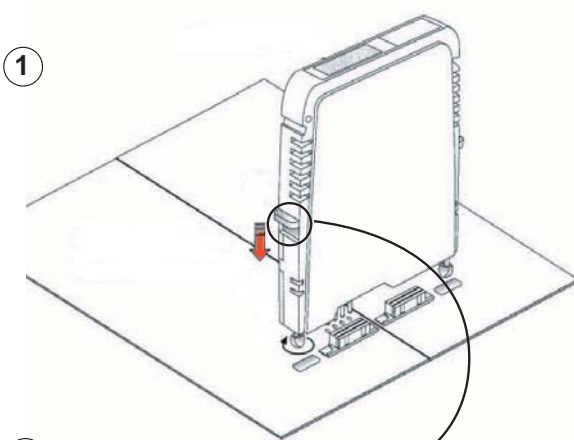

2

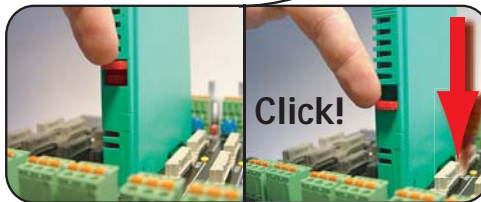

The new module has been installed.

3.2 Connection

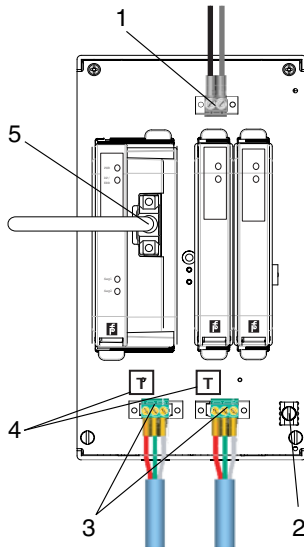

- 1 Power supply connection
- 2 Grounding terminal
- 3 PA trunk connections
- 4 Integral terminators
- 5 PROFIBUS DP connection



Caution!

Communication Problems

Wrong termination may cause communication problems.

Only two active Terminators are allowed per Segment.

3.3 Shielding / Grounding

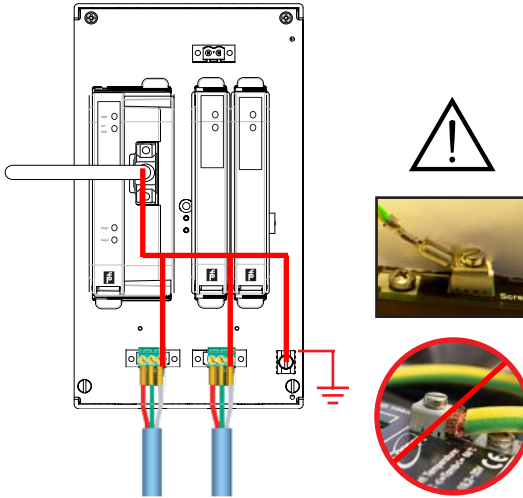

Caution!

This is not a safety earth, although there may be a requirement to earth all exposed metal parts as a matter of course.

Care must be taken to ensure a clean earth at all times.

4 Commissioning

4.1 Cyclic Data Exchange

An appropriate configuration tool is required to configure the cyclic data exchange (define the slaves, user data, etc.) via a PROFIBUS-DP master, class 1.



Preparing the Cyclic Data Exchange

1. If necessary, convert existing GSD files for the PA slaves using the P+F GSD converter, then integrate them into the configuration tool.
2. Adapt the response monitor (watchdog) to the master. Guide value: 5 seconds.

4.1.1 Information on GSD conversion

Because coupling is transparent, PROFIBUS PA nodes are treated like PROFIBUS DP slaves by the PROFIBUS DP Master. This also applies to start-up and configuration.

The GSD file must be integrated in a configuration tool before it can be used to configure and operate a PROFIBUS PA slave.

The following distinctions must always be made between GSD files for PROFIBUS PA slaves:

- is the GSD a profile GSD or a GSD specific to a particular manufacturer?
- is the GSD designed to communicate via the RS 485 interface (DP-GSD) or the interface as per IEC 61158-2 (PA-GSD)?

If a profile GSD is being used, the filename indicates whether it is a DP-GSD or a PA-GSD. For example, file PA039733.gsd is the profile GSD for 4 binary outputs. The "PA" in the filename means it is a PROFIBUS PA slave. The following "0" indicates it is a DP-GSD. The filename of the PA-GSD for the same profile is PA139733. The "1" after the PA abbreviation identifies it as a PA-GSD.

If manufacturer-specific GSDs are used, for example to make use of functionality that falls outside the profile, the following convention identifies whether it is a DP-GSD or PA-GSD:

- If not already done, integrate the GSD into your configuration tool.
- Check which baud rates your configuration tool supports.

If a baud rate of 31.25 kBd is supported, this indicates a PA-GSD. The PA-GSD usually only supports the baud rates 31.25 kBd, 45.45 kBd and 93.75 kBd.

If the data transfer rates are supported as per PROFIBUS specification IEC 61158, i.e. baud rates of 9.6 kBd to 1.5 MBd or 12 MBd, this indicates a DP-GSD. Some PROFIBUS PA field device manufacturers do not offer PROFIBUS DP-GSDs. Existing PROFIBUS PA-GSDs must be converted in this case. Suitable conversion software (GSD converter) is available free of charge at www.pepperl-fuchs.com. The sole function of this conversion software is to enter the missing data transfer rates and set certain bus parameters to values that enable the PROFIBUS DP to operate correctly.

When the GSD file is converted, the following functions are restricted if previously supported by the original GSD file:

- the FREEZE and SYNC functions are disabled. These functions are used with PROFIBUS DPs to synchronize sensors/actuators. and may not work correctly because operations at the PROFIBUS DP end (host end) run at data transfer rates of up to 12 MBd and operations at the PROFIBUS PA end (field end) run at a data transfer rate of 31.25 kBd.

Many PROFIBUS functions are not supported at present. If the field device does not support one or more of the following functions, a warning will appear. This indicates that these will no longer be available after the conversion. The following functions are affected:

- Master class 1 acyclic access

The following PROFIBUS DP V2 functions:

- Data Exchange Broadcast (Publisher/Subscriber)
- Isochronous mode, i.e. synchronous cyclic transmission



Using the Pepperl+Fuchs GSD converter



Note!

The advisory board of the PROFIBUS user organization has agreed not to rescind the certification of GSD files that are modified using Pepperl+Fuchs GSD converter software.

You can select one or more files for conversion by pressing the CTRL or SHIFT keys. Files preceded by a "+" symbol are the result of a previous conversion. These files cannot be converted again and an error message appears if an attempt is made to do so. Files beginning with a "-" symbol have not been converted and can be if required. Double-click to open and view or edit a file.

To convert GSD files, proceed as follows:

1. Start the program PFGSDCX.EXE

The following dialog window appears:

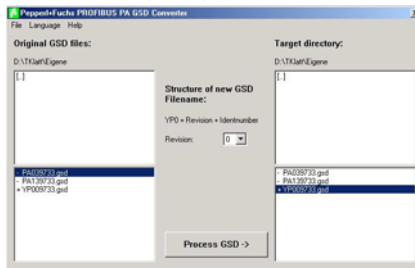

2. Select the directory that contains the GSD files you wish to convert
 3. Select the GSD files you wish to convert
 4. Select the directory where you would like to store the converted GSD files
 5. Convert the GSD files by clicking the "Process GSD -->" button
- Another window opens displaying information on the finished conversion process.



Note!

Visit www.pepperl-fuchs.com to download the Pepperl and Fuchs GSD converter.

4.1.2 Additional Information about Watchdog Time

PROFIBUS devices can activate a mechanism that monitors each time interval in the cyclic data exchange process (also referred to as user data exchange) to ensure that the PROFIBUS master is still active. The time is measured in the PROFIBUS slave.

If the response monitor is active and the time (T_{WD}) since the last cyclic polling process has expired, the device stops the cyclic data exchange, reverts to its original status (Wait_prm) and secures the status of the outputs.

The time value T_{WD} and the signal for activating the response monitor are transmitted from the PROFIBUS master to the PROFIBUS slave in the parameter telegram at start-up (transmitted during the cyclic data exchange). The time T_{WD} is generally defined specific to the user (not device-specific, not in the GSD). Lesser values are limited by the cycle times.

The time T_{WD} is usually entered via the configuration tool. The watchdog setting in the DP/PA gateway is transparent. On some configuration tools, the response monitor is preset once for the PROFIBUS master. While on other tools, the response monitor is preset individually for each PROFIBUS PA participant. The response monitor value does not change in any way. Many tools calculate the time T_{WD} automatically with a corresponding baud rate based on the cycle time of the master.

If the baud rates at the PROFIBUS DP end are high (e.g. 12 MbD), the cycle times of the PA end may be 300 times longer. If a PROFIBUS PA device has been programmed directly with a time T_{WD} calculated at a higher master baud rate (DP), this is usually shorter than the PA cycle and the device does not exchange data. The following bus parameters should be used to ensure the DP/PA gateway operates reliably:

- only one watchdog time T_{WD} is programmed for the entire PROFIBUS system. The longest delay period must be determined in order to define T_{WD}
- one watchdog time T_{WD} is programmed for each individual slave.

The preset (programmed) time T_{WD} must be greater than the maximum occurring delay period T_{V_max} . This is determined as follows:

$$T_{V_max} = T_{cycle_DP} + T_{cycle_PA_channel}$$

with $T_{cycle_PA_channel}$ = cycle time of the PROFIBUS PA channel

T_{cycle_DP} = cycle time of the PROFIBUS DP

Pepperl+Fuchs recommends a value three times the PROFIBUS PA cycle time.

The PA cycle time $T_{cycle_PA_channel}$ depends on:

























- the number n of devices attached to the bus on one channel
- the user data length L

The user data length L is a unitless variable calculated as an average quantity of user data input and output (in bytes) for all devices.

The following is an approximate calculation for the cycle time: $T_{cycle_PA_channel} = n * (0.256 \text{ ms} * L + 12 \text{ ms}) + 40 \text{ ms}$

5 Operation

5.1 LED Displays at the DP/PA Gateway

LED display	Possible cause	Remedy
PWR  DP/ERR  SEG1  SEG2 	DP/PA Gateway in operation.	
PWR  DP/ERR  SEG1  SEG2 	No power supply	Check the power supply
	Gateway defective	Restart the Gateway, send Gateway back if the problem persists
PWR  DP/ERR  SEG1  SEG2 	No data exchange at the DP end	Check the cable Check the termination
	Master problem	Check the master
	Gateway defective	Restart the Gateway, send Gateway back if the problem persists
PWR  DP/ERR  SEG1  SEG2 	Hardware fault	Restart the gateway, send gateway back if the problem persists
PWR  DP/ERR  SEG1  SEG2 	Address collision, the same address is assigned to two field devices on two segments	Modify the address of one PA slave
PWR  DP/ERR  SEG1  SEG2 	Hardware fault (LED SEG1 or SEG2)	Restart the Gateway, send Gateway back if the problem persists

200058-2007-02

5.2 LED Displays on the Power Supply Module

LED display	Possible cause	Remedy
<p>● PWR ○ ERR</p>	Power Supply Module in operation.	
<p>○ PWR ● ERR</p>	Defective power supply: < 17.5 VDC ± 4% > 36.8 VDC ± 4%	Check the power supply
	Module defective	Send in the module for inspection

PROCESS AUTOMATION – PROTECTING YOUR PROCESS



Worldwide Headquarters

Pepperl+Fuchs GmbH
68307 Mannheim · Germany
Tel. +49 621 776-0
E-mail: info@de.pepperl-fuchs.com

For the Pepperl+Fuchs representative
closest to you check www.pepperl-fuchs.com/pfcontact

www.pepperl-fuchs.com

Subject to modifications
Copyright PEPPERL+FUCHS • Printed in Germany

 **PEPPERL+FUCHS**
PROTECTING YOUR PROCESS

200058 / TDOCT-1240__ENG

02/2007