

Level measurement with Radar for liquids

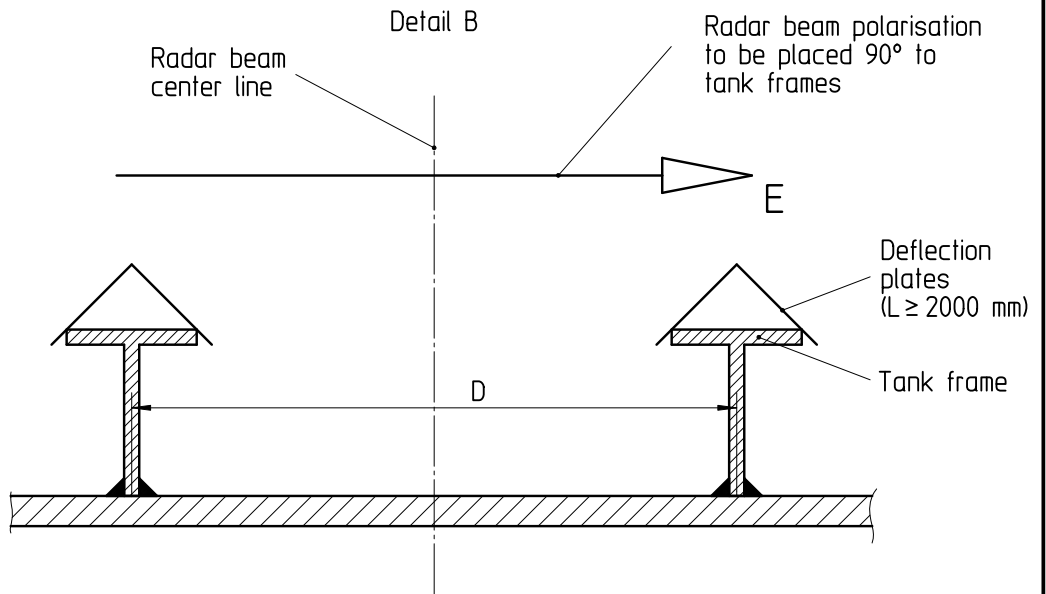
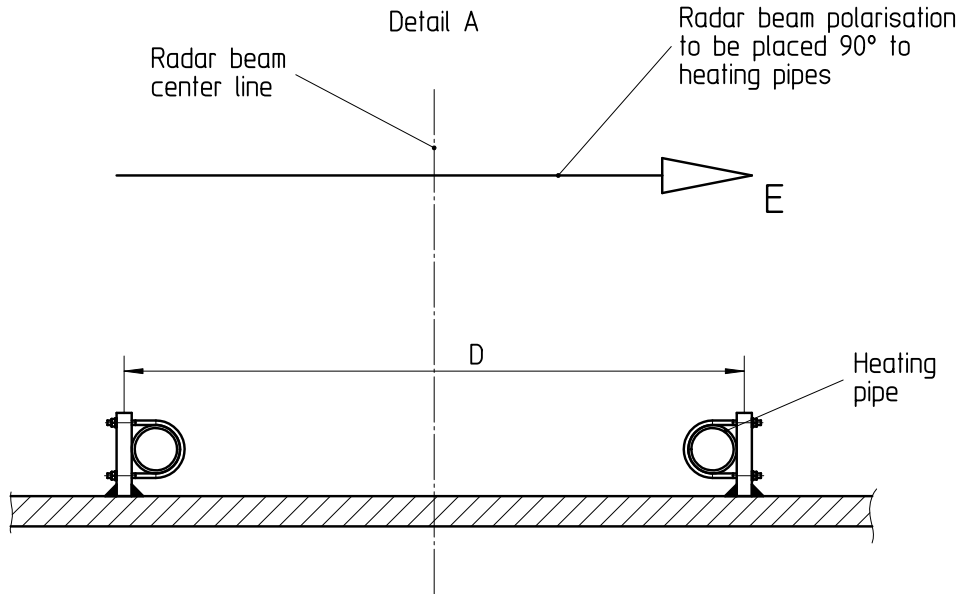

Application	
Cargo	X
HFO storage	
HFO settling	
HFO service	
MDO	
Fresh water	X
Potable water	X
Black water	X
Grey water	X
Salt water ballast	
Salt water draft	
Sludge	
Lub oil	

Diese Zeichnung bleibt Eigentum der Firma VEGA-Grieshaber KG. Sie darf ohne unsere Genehmigung weder kopiert, noch 3. Personen oder Konkurrenzfirmen mitgeteilt werden. (§ 2 Abs.1 Ziff.7 UrHG vom 09.09.1965)

This drawing remains property of VEGA-Grieshaber KG. It may be neither copied nor informed to third persons or competitors without our approval. (§ 2 paragraph 1 fig.7 copyright act of 9th Sept. 1965)

Passmaß/tol.dimens.	Abmaß/allowance	Änderung / changing			Datum / Date	gezeichnet / freigegeben drawn / checked	
	Freimaßtoleranz general tolerance ISO 2768-mK	gezeichnet drawn freigegeben checked	Datum/Date 07.09.2006 14.09.2006	Name/Name Oberfäll Oberfäll	Benennung VEGAPULS62 at standard ship application	Description VEGAPULS62 at standard ship application	
Werkstoff / Material		Maßstab Scale 1:5	 VEGA Grieshaber KG Postfach 1142 77757 Schiltach Germany		Art.Nr. / Art.No. MB2609-A	Änd.-Zust. / Vers. -	
		Originalformat size of origin A4			Zchngs.-Nr. / Drawing No. MB2609-A	Var.Fam.2: Ersatz f. / replacement f.	
			Teil ähnl. / sim. part		Arb.Anw. / work.instr.		